



## VISION

To become a leading manufacturer in Turkey with an organisation that closely follows and applies technological developments, aims to act as one with its employees, customers and suppliers. To have international quality standards and image, and contributes to Turkish economy.

## MISSION

Responding to the needs of our consumers by prioritising customer satisfaction, providing a quality service exceeding the customer expectations by adopting the principle of continuous improvement, ensuring competitive prowess whilst staying loyal to our current values, and adopting and applying modern management systems.

<b>LASER SLITTING &amp; CUTTING MACHINE</b>	<b>4</b>
<b>ULTRASONIC FABRIC SLITTING MACHINE</b>	<b>6</b>
<b>DOUBLE FOLDING-ROLLING &amp; TWICE DOUBLE FOLDING MACHINE</b>	<b>8</b>
<b>ROLL END &amp; EDGES SEWING MACHINE</b>	<b>10</b>
<b>PRECISION PLAITING/FOLDING MACHINE</b>	<b>12</b>
<b>BEAM WINDING MACHINE</b>	<b>14</b>
<b>TUBULAR FABRIC INSPECTION MACHINE</b>	<b>16</b>
<b>INSPECTION MACHINES FOR KNITTED FABRIC (OPEN WIDTH)</b>	<b>18</b>
<b>FINISHED FABRIC INSPECTION &amp; ROLLING (KNITTED) MACHINE</b>	<b>20</b>
<b>FABRIC INSPECTION &amp; ROLLING MACHINES (WOVEN FABRICS)</b>	<b>22</b>
<b>FABRIC INSPECTION &amp; ROLLING MACHINES</b>	<b>24</b>
<b>BATCHING &amp; ROLLING MACHINERY</b>	<b>26</b>
<b>FABRIC INSPECTION &amp; BATCHING MACHINES</b>	<b>28</b>
<b>J-BOX UNITS</b>	<b>30</b>
<b>BATCHING, ROLLING &amp; PLAITING MACHINES</b>	<b>32</b>
<b>PLAITING/FOLDING MACHINERY</b>	<b>34</b>
<b>IN-LINE SLITTING MACHINERY</b>	<b>36</b>
<b>COMPACT INSPECTION &amp; ROLLING MACHINERY</b>	<b>38</b>
<b>WET ROPE OPENING MACHINE</b>	<b>40</b>
<b>EMBROIDERY CUTTING &amp; SLITTING MACHINERY</b>	<b>42</b>
<b>SIMPLE FABRIC ROLL WRAPPING MACHINE</b>	<b>44</b>
<b>FULLY AUTOMATIC FABRIC INSPECTION &amp; ROLL WRAPPING MACHINE</b>	<b>46</b>
<b>FULLY AUTOMATIC ROLL PACKING MACHINE (LARGE DIAMETER ROLLS)</b>	<b>48</b>
<b>FULLY AUTOMATIC ROLL PACKING MACHINE</b>	<b>50</b>
<b>SAMPLE BOOK MANUFACTURING EQUIPMENT</b>	<b>52</b>
<b>OPTION GROUPS &amp; END-TO-END SEAM (RAILWAY SEWING)</b>	<b>54</b>

## LASER SLITTING & CUTTING MACHINE

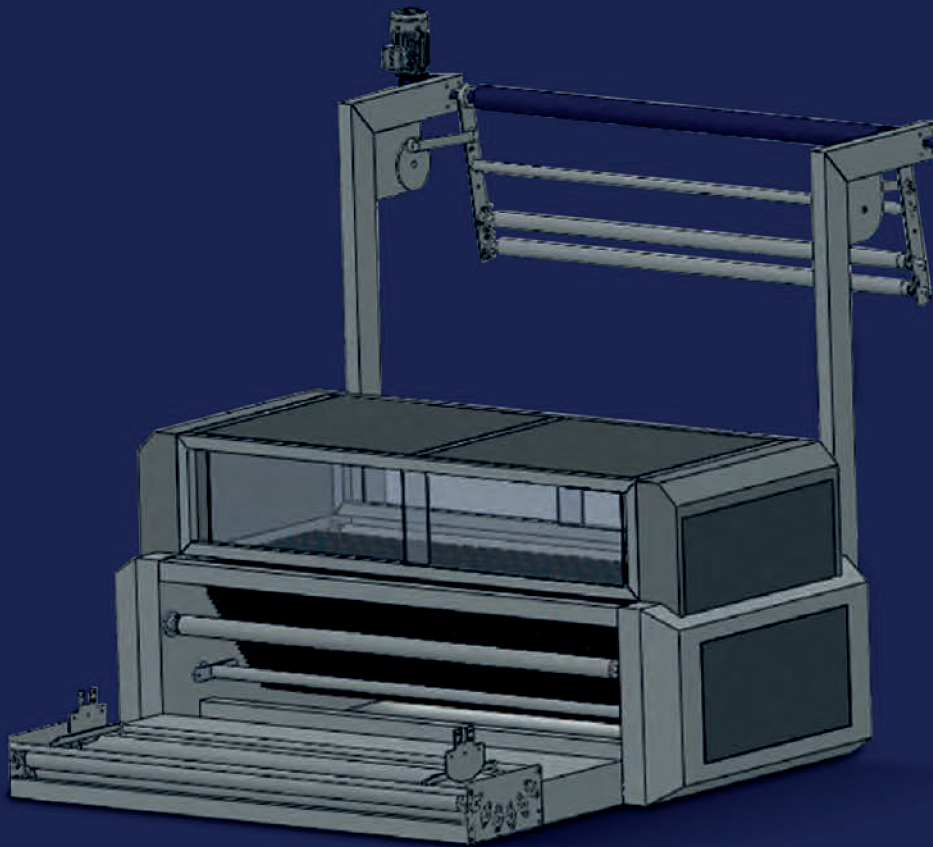

Weaving, tulle, organza, embroidery, voile, jacquard etc. fabrics edge pattern laser cutting with camera system for edge recognition

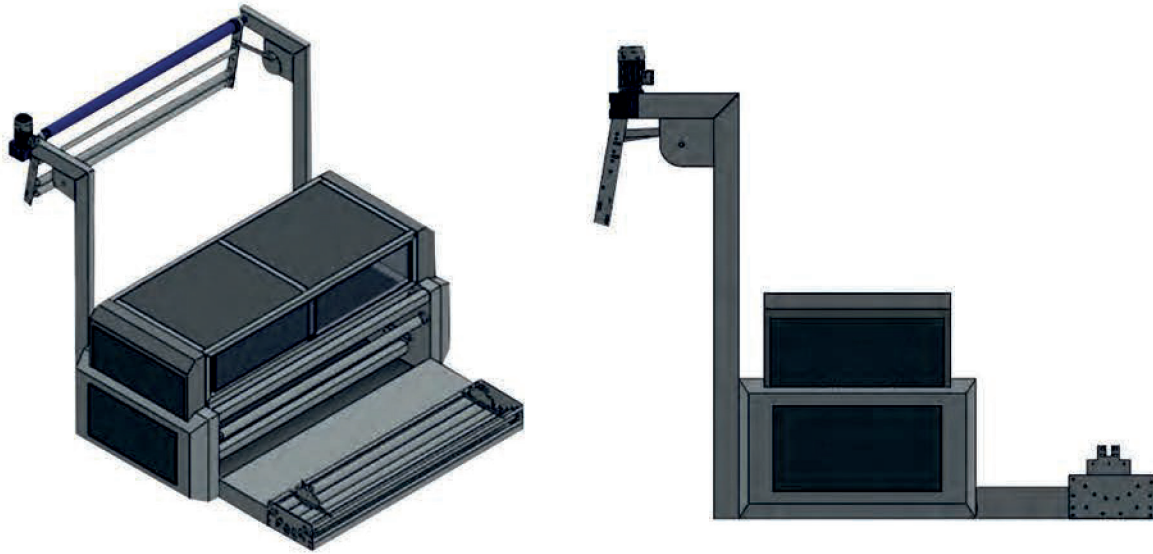

## TECHNICAL SPECIFICATIONS

- Up to 24 m/minute working speed
- Roll end detection by photocell
- Roll-to-roll/roll-to-plaiting/folding
- Tension control system
- Selvedge removal system
- Special long life laser tube
- Demas produce with TUBITAK R&D

# ULTRASONIC FABRIC SLITTING MACHINE



Fabric slitting machine with ultrasonic technology.

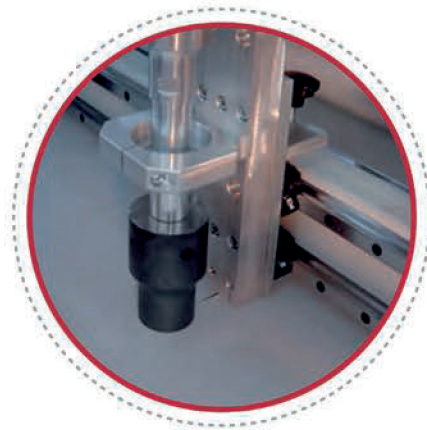

## **TECHNICAL SPECIFICATIONS**

- **Cutting all types of fabric with ultrasonic technology**
- **Ideal for synthetic fabric slitting and welding**
- **Fabric control screen addition before fabric cutting**
- **Electronic speed up to 25m/minute**

## DOUBLE FOLDING-ROLLING & TWICE DOUBLE FOLDING MACHINE

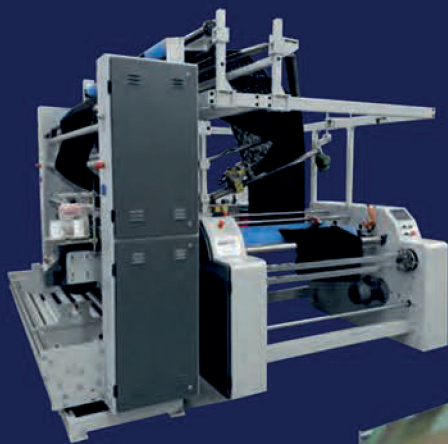

T.2011



T.2013

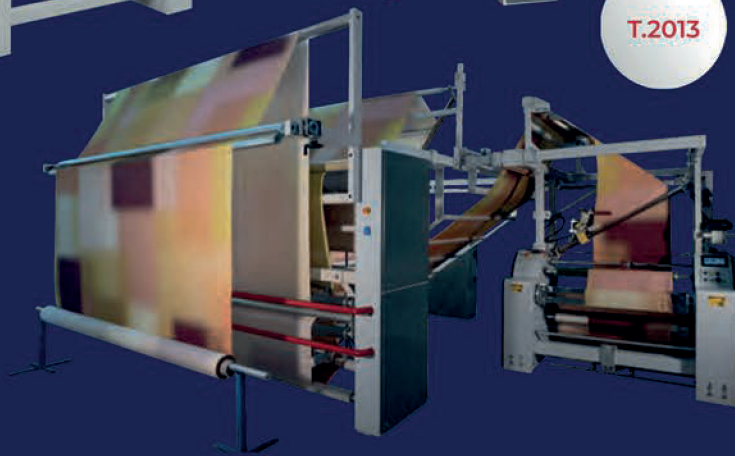

T.2016

Folds fabrics such as: woven, tulle, organza, brode, voile, jacquard etc. into twofold and fourfold package.





## TECHNICAL SPECIFICATIONS

- **Fabric entry is the same for double and four folding**
- **Special system to handle thin and sensitive fabrics**
- **The smoothness of the fabrics folded in two/four is ensured by the photocell edge holder group or the pneumatic right-left folding smoothness system.**
- **Electronically adjustable fabric tension on the machine**
- **The length of the fabric is precisely measured with a calibrated digital metercounter.**
- **Hard or loose folding feature, due to torque controlled, from beginning of the roll to end of the roll**
- **Adjustable electronic calibrated counter meter system adjustable speed control up to 60 m/minute)**
- **Sensor free roll rewinding**

## ROLL END & EDGES SEWING MACHINE

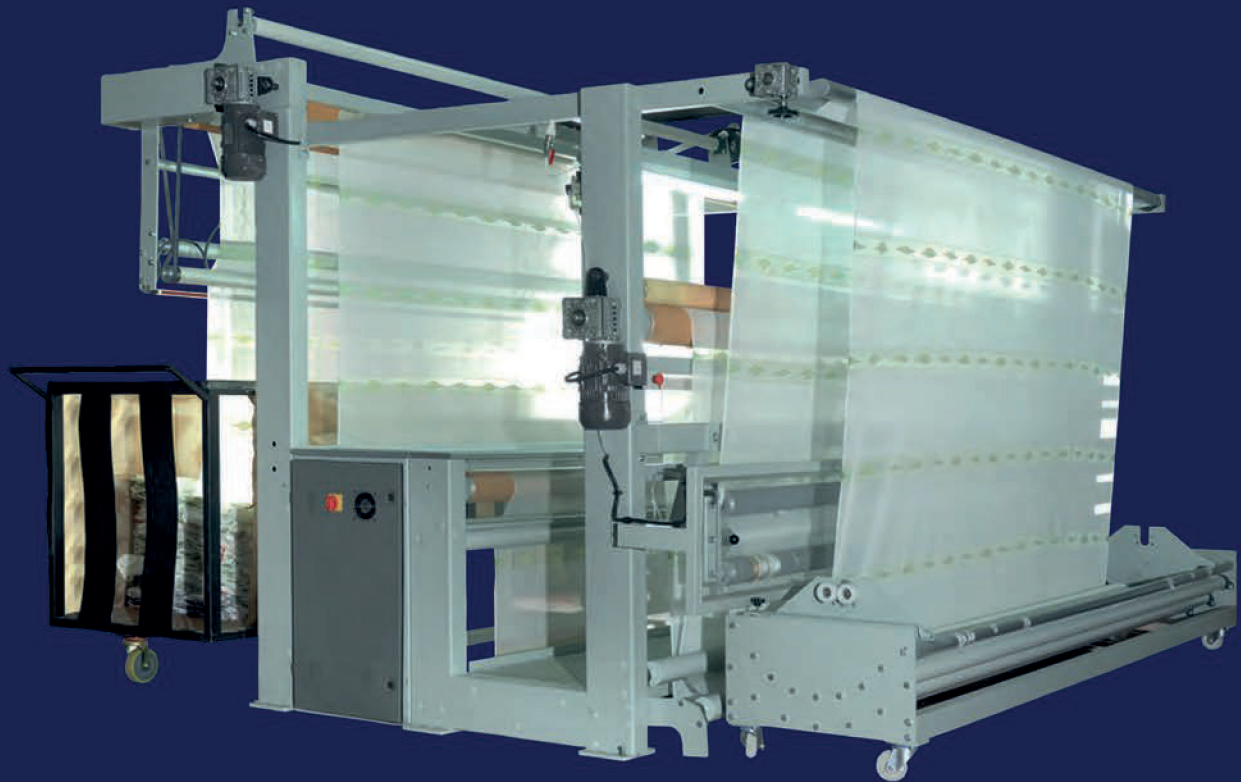

Sew the lead band to the edge of fabric.  
Materials such as organza and curtains.

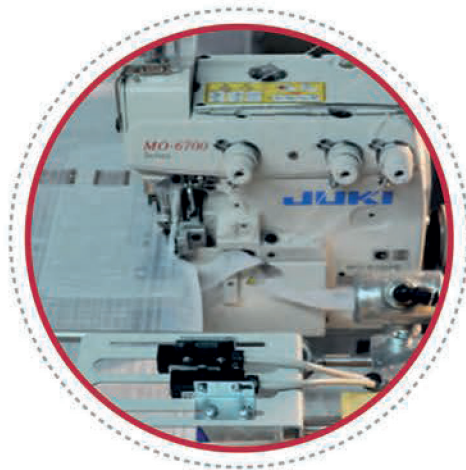

## TECHNICAL SPECIFICATIONS

- Synchronised working due to electronic tension adjustment
- From entrance to exit of the fabric, tension adjustment and controllable transport feature
- Selvedge photocell guide, adjustable according to the sliding speed of fabric before sewing
- Working speed up to 13 m/minute
- Automatic end stop sensor
- Fabric edge guide sensor before overlock sewing
- Stop sensor when yarns break
- Vacuum system for fabric selvedge

# PRECISION PLAITING/FOLDING MACHINE

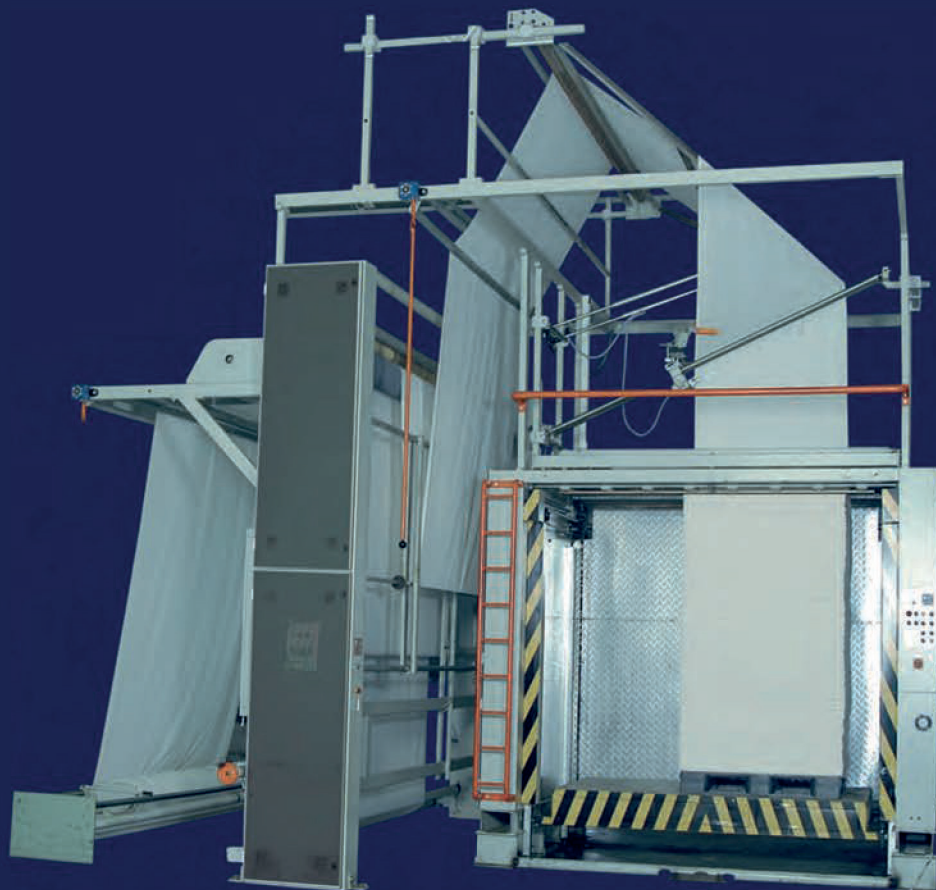

Roll to plaited/folded incorporating  
fabric inspection system



## TECHNICAL SPECIFICATIONS

- Working width 1800mm up to 3600mm
- Working height (1400mm and 2000mm)
- Automatic lay down system according to the thickness of the fabric
- Dancing bar tensioning system to able speeds up to 40 m/minute
- Edge control system
- Puller roller tensioning system on fabric entry

# BEAM WINDING MACHINE



Beam winding machine  
for woven fabrics

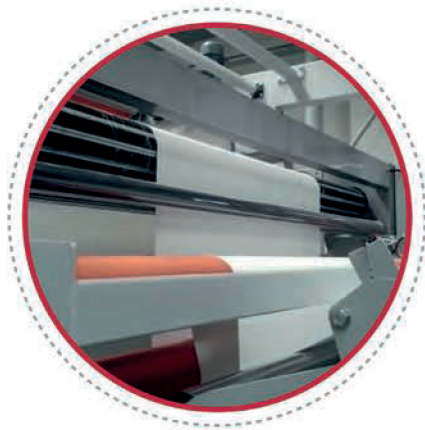

## TECHNICAL SPECIFICATIONS

- **Rolling diameters up to 1200mm**
- **Automatic narrowing and expanding according to lengths of beam between diameter 1400mm and 3600mm**
- **Fabric centering group with photocell**
- **Smooth rolling by fabric edge control system**
- **Electronic metre recording system**
- **Plaiting backward (Optional)**
- **Expander unit (Optional)**
- **Crane Group (Optional)**

# TUBULAR FABRIC INSPECTION MACHINE



Inspection and rewinding machine used to inspect tubular knitted fabric on a double screen tray





## TECHNICAL SPECIFICATIONS

- **Inspection panel is protected from daylight aid by covering cabin and is illuminated by varied lamps**
- **Synchronised unwind and rewind**
- **Expander roller system for eliminating the curled fabric edges**
- **Darkened hood to provide optimum viewing conditions**
- **Air control system to eliminate edge curling.**

## INSPECTION MACHINES FOR KNITTED FABRIC (OPEN WIDTH)



R.101.3



R.101.5



R.101.4

Inspection and rewinding machine by controlling open-width raw knitted fabrics without stretching or harming the fabric.



## TECHNICAL SPECIFICATIONS

- Expander roller system for eliminating the curled fabric edges
- Automatic stopping roll end/required meterage system
- Calibration values can be separately defined for each type of fabric
- Darkened hood to provide optimum viewing conditions
- It has edge control unit with photocell in order to roll smoothly
- Roll weighing system
- Barcode printing system
- Tubular to tubular working
- Tubular to open width (optional)

# FINISHED FABRIC INSPECTION & ROLLING (KNITTED) MACHINE



R.401.50



R.401.51

Inspection machine  
for knitted fabrics

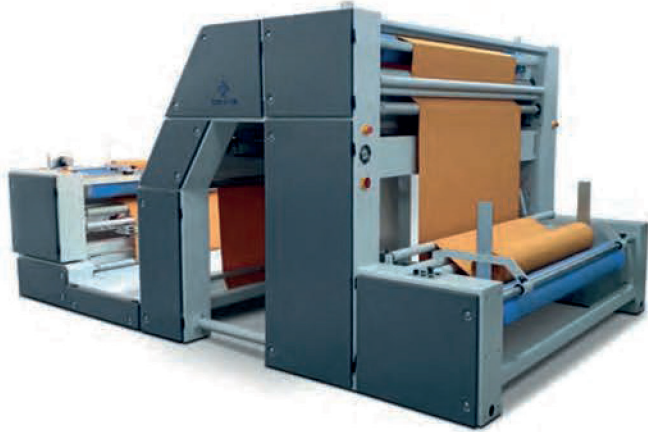

## TECHNICAL SPECIFICATIONS

- **Fabric entry via conveyerised system to minimise stretching**
- **Air control system for eliminating fabric edge curling**
- **Automatic end stop sensor**
- **It has edge control unit with photocell in order to roll smoothly**
- **Calibration values can be separately defined for each type of fabric**
- **Darkened hood to provide optimum viewing conditions**
- **Roll weighing system**
- **Barcode printing system**

# FABRIC INSPECTION & ROLLING MACHINE (WOVEN FABRICS)



Inspection machines  
for woven fabrics

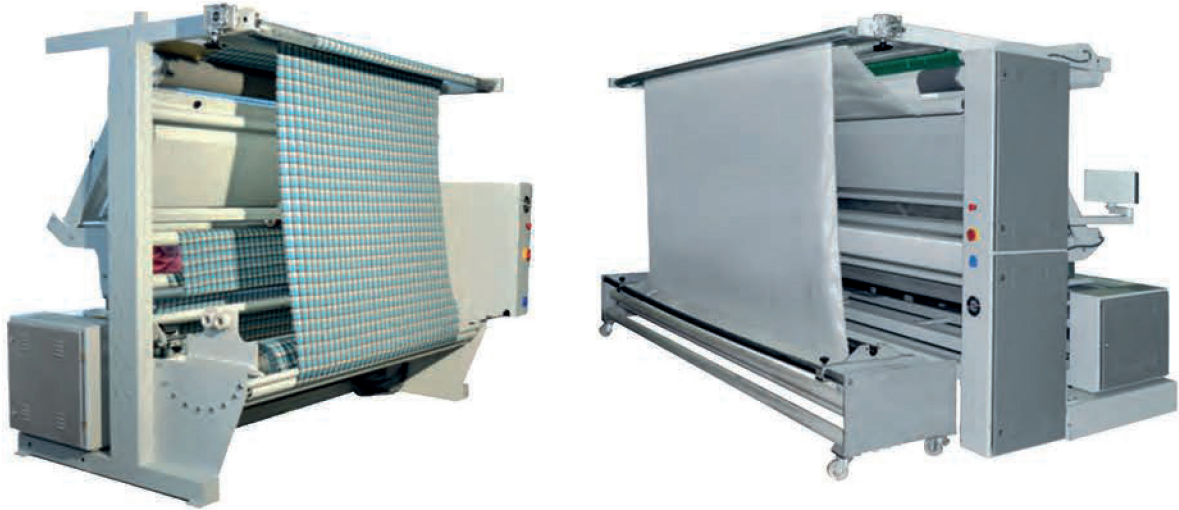

## TECHNICAL SPECIFICATIONS

- **Automatic stopping roll end/required meterage system**
- **Adjustable roll hardness**
- **Edge control system**
- **Calibration values can be separately defined for each type of fabric**
- **Adjustable speed control up to 60 m/minute**
- **Roll box**
- **Roll weighing system**
- **Barcode printing system**

# FABRIC INSPECTION & ROLLING MACHINE



R.401.21



R.401.27



R.303

Inspection machines  
for woven fabric





## TECHNICAL SPECIFICATIONS

- **Automatic stopping roll end/required meterage system**
- **Adjustable roll hardness**
- **Edge control system fitted with photocell**
- **Calibration values can be separately defined for each type of fabric**
- **Adjustable speed control up to 60 m/minute**
- **Roll box**
- **Roll weighing system**
- **Barcode printing system**

## BATCHING & ROLLING MACHINERY

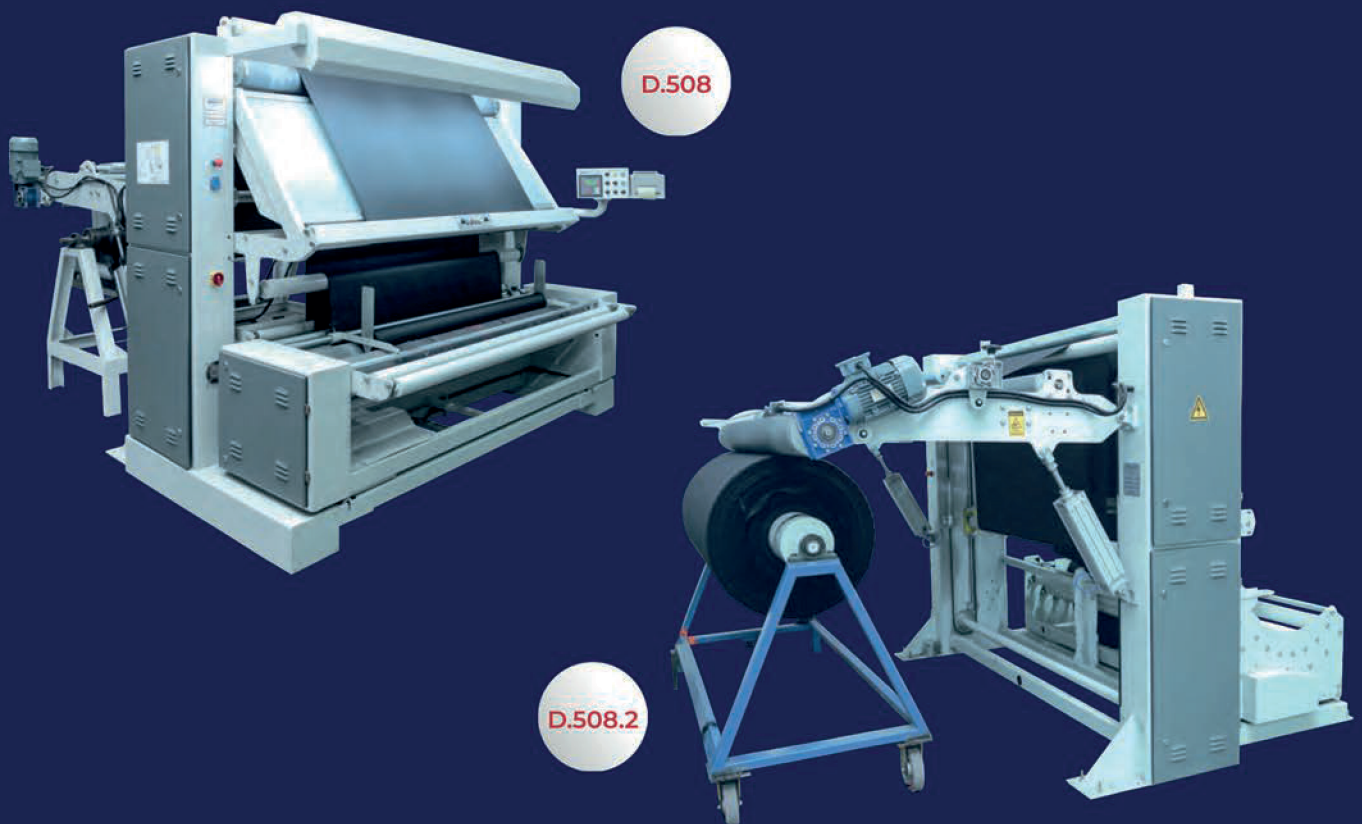

Wide range of batching machinery such as batching arm, A-frames, inspection, big-batch and plaited



## **TECHNICAL SPECIFICATIONS**

### **A-FRAME BIG ROLL UNWINDING**

- **Automatic stopping roll end/required meterage system**
- **Calibration values can be separately defined for each type of fabric**
- **Speed control up to 60 m/minute**
- **Banana Roller**
- **Roll weighing system**
- **Barcode printing system**

# FABRIC INSPECTION & BATCHING MACHINES

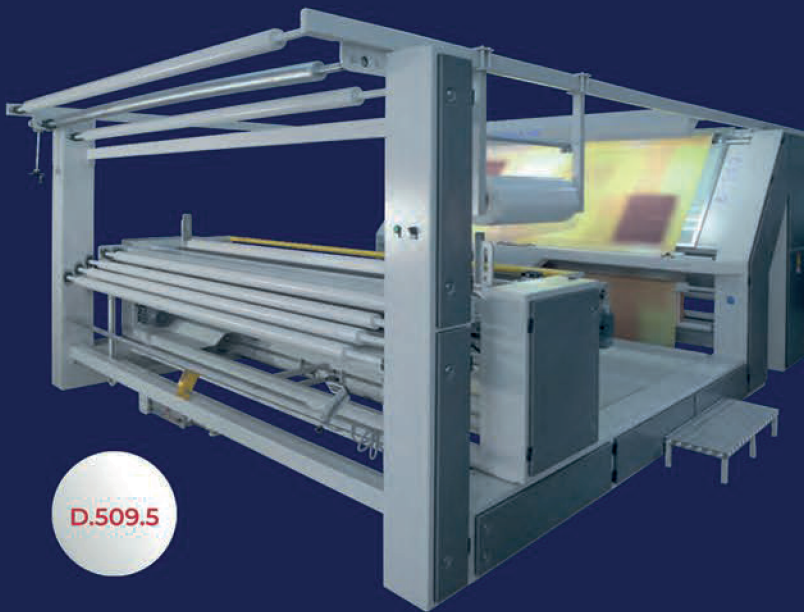

D.509.5



D.103.10



Rewind raw fabrics from small rolls to big batch.  
Also used for fabric control from big batch to big batch



## TECHNICAL SPECIFICATIONS

- Automatic stopping roll end/required meterage system
- Calibration values can be separately defined for each type of fabric
- Speeds of up to 0-80 m/minute
- Stainless J-Box group
- Banana Roller
- Centering group by sensors
- Fabric end to end sewing system

## J-BOX UNITS



Group required for non-stop operation of fabrics coming from small rolls at the entrance of large production machinery



## TECHNICAL SPECIFICATIONS

- **Speeds of up to 80 m/minute**
- **Unwinding group from roll without tension (optional)**
- **Fabric end to end sewing system (optional)**

## BATCHING, ROLLING & PLAITING MACHINES

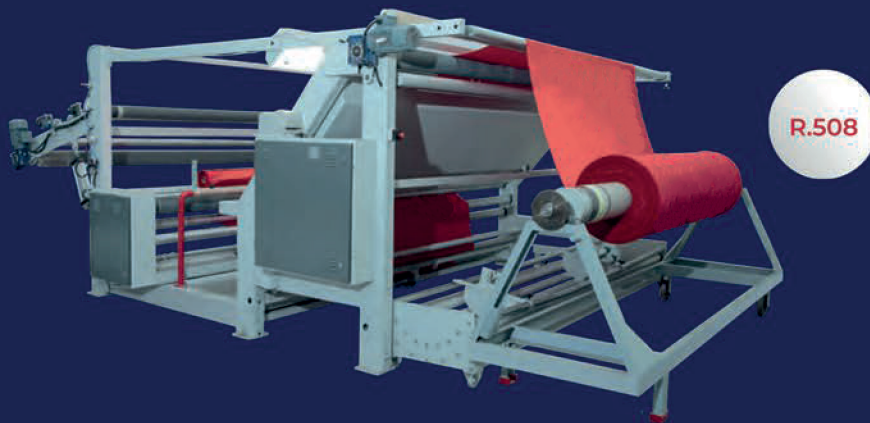

Batching, rolling and plaiting machine after inspection the fabrics came from trolley, roll and batch





## TECHNICAL SPECIFICATIONS

- **Automatic stopping roll end/required meterage system**
- **Calibration values can be separately defined for each type of fabric**
- **Speeds of up to 60 m/minute**
- **Banana Roller**
- **Operator platform with photocell**
- **Roll weighing system**
- **Barcode printing system**

## PLAITING/FOLDING MACHINERY



Machine for unwinding of rolled fabric to plait in trolley



## OPTIONS

- Quality control screen
- Metercounter

## IN-LINE SLITTING MACHINERY



In-line slitting machine for  
precision slitting of rolled fabrics



## TECHNICAL SPECIFICATIONS

- **Various options of cutting methods**
- **Dual rewinding system**
- **Air shafts**
- **Electronic length measuring system**
- **Centering system at the fabric entrance (optional)**
- **Shear cutting system for laminated and special products (optional)**

# COMPACT INSPECTION & ROLLING MACHINERY

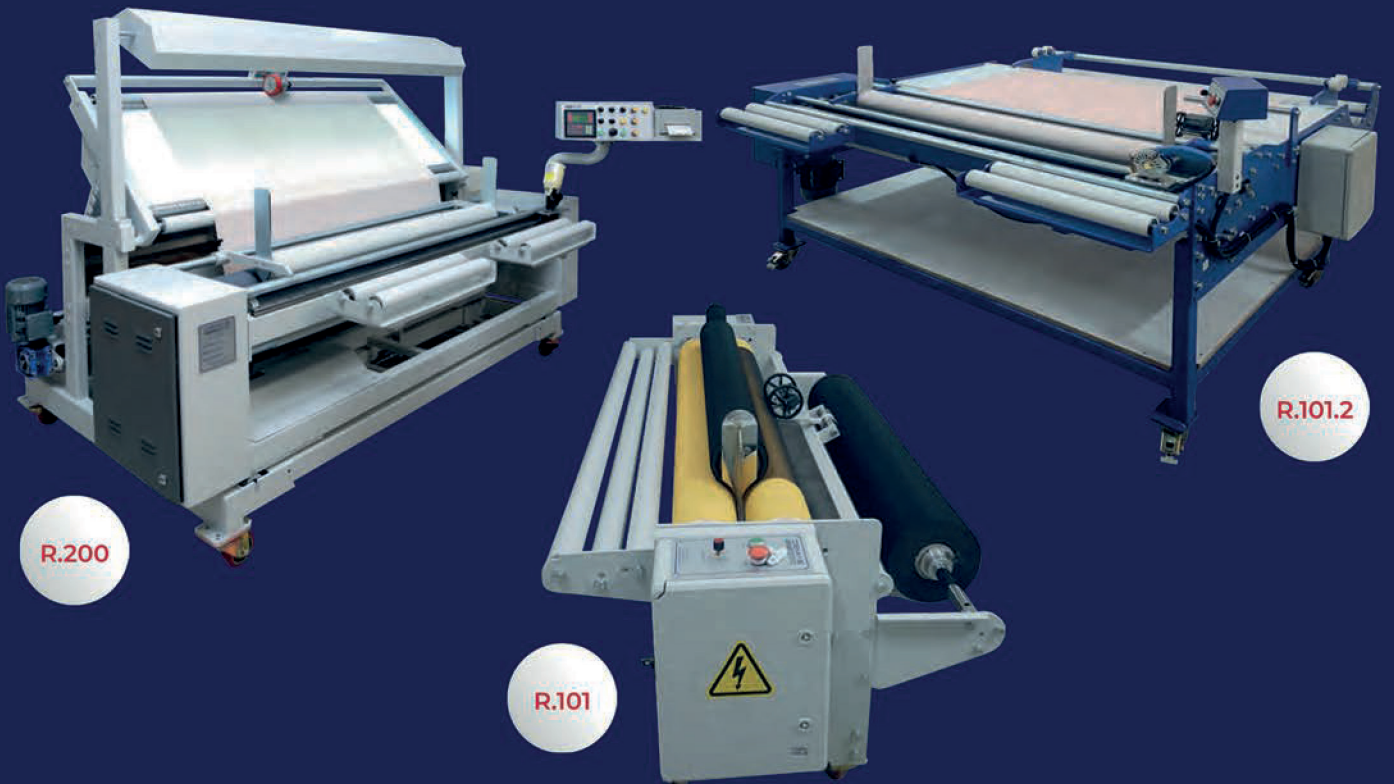

Machines for fabric quality control  
and wrapping for knitted and woven fabrics



D.508.1

## TECHNICAL SPECIFICATIONS

- The possibility of rolling in short length rolls
- Smooth and efficient winding with fabric edge control system
- Automatic stopping roll end/required meterage system
- Machine is on casters and is easily moveable
- Length/cross-cutting blades (optional)

## WET ROPE OPENING MACHINE

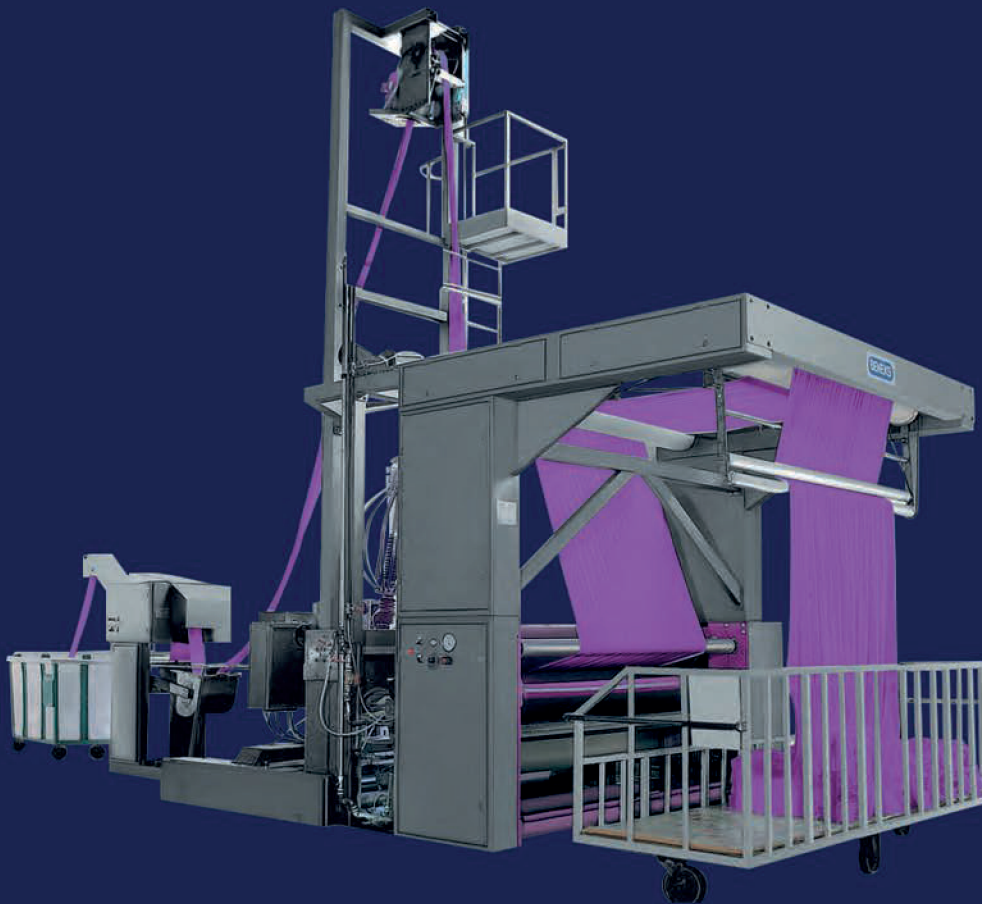

Machine used for expanding and spreading the wrinkled woven dyed or washed fabrics by automatic or manual control





## TECHNICAL SPECIFICATIONS

- **Automatic detwister controlled by inverter for woven fabrics**
- **Stainless steel scroller device**
- **Centering group controlled by pneumatic system**
- **Maximum speed up to 60 m/minute**
- **Selvedge position detector**
- **Turning table unit (by photocell controlled) [optional]**
- **Wet rope front squeezing groups (optional)**
- **Open width squeezing and foulard unit (optional)**
- **Complete stainless or epoxy painted production (optional)**

# EMBROIDERY CUTTING & SLITTING MACHINERY



K.100



K.101

Practical solution for embroidery cutting



## TECHNICAL SPECIFICATIONS

- **Cut fabrics without tension by placing a roll with a max diameter of 400mm on the roll unwinding system**
- **Automatic stop at desired meter**
- **Pneumatic tightening system for precise fabric cutting**
- **Quality control display attachment (optional)**
- **Portable roll winding group (optional)**

## SIMPLE FABRIC ROLL WRAPPING MACHINE



Semi-automatic roll packaging for woven and knitted fabric rolls. Rolls are placed on the machine manually and lifted after the packaging process

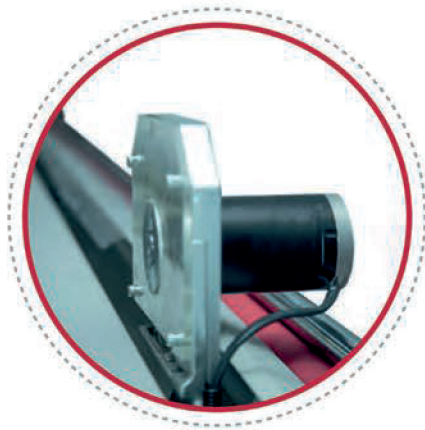

## TECHNICAL SPECIFICATIONS

- It is suitable for packing minimum 150mm maximum 350mm fabric rolls diameter
- Packing capacity up to 60 rolls/hour
- With the help of sensed automatic diameter measurement system, can be measured the diameter of the roll in entrance by sensors and plastic film waste is reduced according to roll diameter
- Edge closing of the roll is done by hot air guns at each roll end and melts the film to seal. The linear roll sealing is done via a heated bar.

## FULLY AUTOMATIC FABRIC INSPECTION & ROLL WRAPPING MACHINE



Fully Automatic Roll Packaging machine, attached to the inspection and rolling machine. Suitable for quality control, rewinding without shrinkage of open-width knitted and woven fabric rolls



## TECHNICAL SPECIFICATIONS

- Possibility to move the fabric to the control screen freely with the sensor controlled conveyor system
- Electronic meter measurement system. (Meter tolerance according to the measurement in the free state of fabric is 0.4%)
- Smooth and tight winding with fabric edge following system
- Possibility of rolling without twisting the fabric thanks to spreading opener rollers
- Automatic stopping roll end/required meterage system
- Motorised cross cutter for fabric length (automatic)
- Roll weighing system
- Barcode printing system
- Minimum PE film, consumption thanks to the diameter measuring sensor
- Length welding system with thermal system
- Packed roll pneumatic piston transfer unit to the transport trolley
- With touch screen control panel

## FULLY AUTOMATIC ROLL PACKING MACHINE (LARGE DIAMETER ROLS)



Fully Automatic Roll Packaging machine which the fabrics are automatically packed and transported to the roll carry trolley by addressing along a line starting from the Quality Control machine



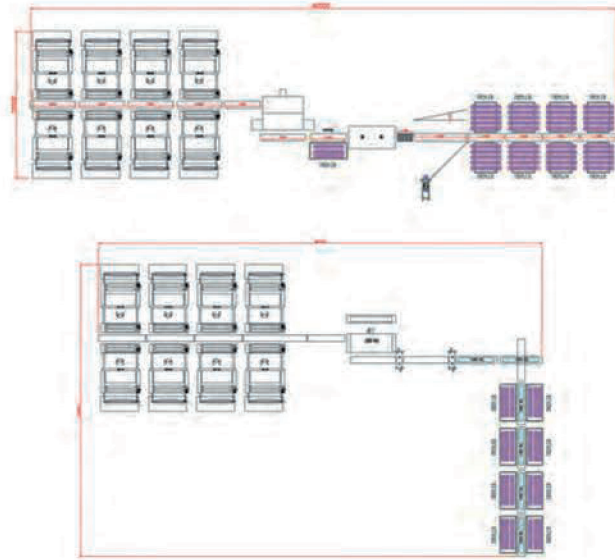

## TECHNICAL SPECIFICATIONS

- Fabric rolls wrapping with P.E film, side sealing with thermal welding method
- Up to 100 rolls/hour packing capacity
- Packaged roll is passed through shrink unit for close-fitting wrapping
- Multi-loading from roll machine to conveyors and automatic pinpoint multi-dispatching to carriages
- Specific solutions for packing of big diameter rolls

## FULLY AUTOMATIC ROLL PACKING MACHINE



Fully automatic roll packaging machine which is integrated to quality control machines for woven, knitted and other fabric types and pack the fabric rolls automatically, after packing process the rolls are addressed along a line starting from the quality control machines to the roll carry trolleys.

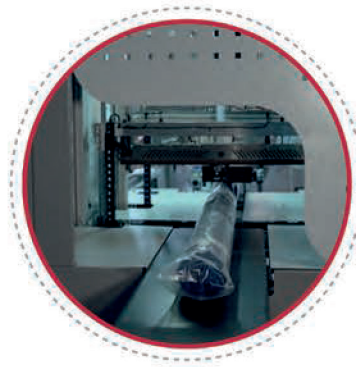

## TECHNICAL SPECIFICATIONS

- Roll packing of different length rolls
- Minimum P.E and energy consumption
- Shrink tunnel for stretched and transparent packs at the end of packaging

# SAMPLE BOOK MANUFACTURING EQUIPMENT

WATERFALL SYSTEMS, SAMPLE CUTTING/PINKING TABLE



K.1002

Machine that provides the bonding of sample fabrics of different colours and patterns.



## TECHNICAL SPECIFICATIONS

- Our waterfall machine is capable of working width of 850mm
- Our pinking sample cutting machine provides an accurate X/Y cutting of predetermined sizes
- Machines are available in manual, semi-automatic and fully automatic versions
- Machines can handle single or multi-layer cuttings. Pile height depends on machine model

## OPTION GROUPS & END-TO-END SEAM (RAILWAY SEWING)



SPECIAL BLADES



PRINTER



METER COUNTER



R.908

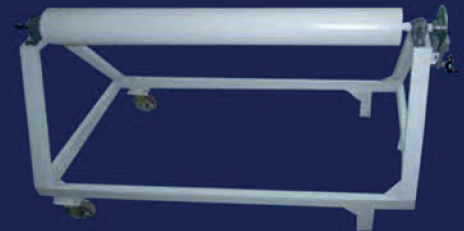

A-FRAME CARRIER



P.908

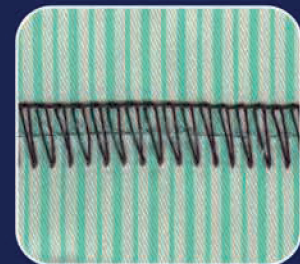

## TECHNICAL SPECIFICATIONS

- Ends of fabric rolls is held together end-to-end by sewing with merrow mark sewing machine
- Sewing machine moves automatically on rail





**Email: [enquiries@i2europe.co.uk](mailto:enquiries@i2europe.co.uk)**

**Website: [www.i2europe.co.uk](http://www.i2europe.co.uk)**